

Description

The XXW20P02 uses advanced trench technology to provide excellent $R_{DS(ON)}$, low gate charge and operation with gate voltages as low as 2.5V. This device is suitable for use as a Battery protection or in other Switching application.

General Features

$V_{DS} = -20V$ $I_D = -20A$

$R_{DS(ON)} < -18m\Omega$ @ $V_{GS} = -4.5V$

Application

Battery protection

Load switch

Uninterruptible power supply

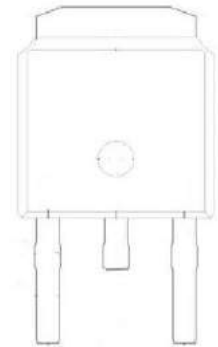
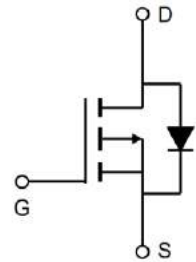

Absolute Maximum Ratings ($T_C = 25^\circ C$ unless otherwise noted)

Symbol	Parameter	Rating	Units
V_{DS}	Drain-Source Voltage	-20	V
V_{GS}	Gate-Source Voltage	± 12	V
$I_D @ T_C = 25^\circ C$	Continuous Drain Current, $V_{GS} @ -4.5V^1$	-20	A
$I_D @ T_C = 70^\circ C$	Continuous Drain Current, $V_{GS} @ -4.5V^1$	-12	A
I_{DM}	Pulsed Drain Current ²	-60	A
$P_D @ T_C = 25^\circ C$	Total Power Dissipation ³	39	W
$P_D @ T_C = 70^\circ C$	Total Power Dissipation ³	20	W
T_{STG}	Storage Temperature Range	-55 to 150	$^\circ C$
T_J	Operating Junction Temperature Range	-55 to 150	$^\circ C$
$R_{\theta JA}$	Thermal Resistance Junction-Ambient ¹	65	$^\circ C/W$
$R_{\theta JA}$	Thermal Resistance Junction-Ambient ¹ ($t \leq 10s$)	36	$^\circ C/W$
$R_{\theta JC}$	Thermal Resistance Junction-Case ¹	3.2	$^\circ C/W$

Electrical Characteristics (TA=25°C unless otherwise noted)

Symbol	Parameter	Test Condition	Min.	Typ.	Max.	Units
V(BR)DSS	Drain-Source Breakdown Voltage	$V_{GS}=0V, I_D=-250\mu A$	-20	-	-	V
VGS(th)	Gate Threshold Voltage	$V_{DS}=V_{GS}, I_D=-250\mu A$	-0.4	-0.7	-1.0	V
RDS(on)	Static Drain-Source on-Resistance note2	$V_{GS}=-4.5V, I_D=-5A$	-	15	18	mΩ
RDS(on)	Static Drain-Source on-Resistance note2	$V_{GS}=-2.5V, I_D=-3A$	-	17	25	
IDSS	Zero Gate Voltage Drain Current	$V_{DS}=-20V, V_{GS}=0V,$	-	-	-1	μA
IGSS	Gate to Body Leakage Current	$V_{DS}=0V, V_{GS}=\pm 12V$	-	-	±100	nA
Ciss	Input Capacitance	$V_{DS}=-15V, V_{GS}=0V,$ $f=1.0MHz$	-	2700	-	pF
Coss	Output Capacitance		-	680	-	pF
Crss	Reverse Transfer Capacitance		-	590	-	pF
Qg	Total Gate Charge	$V_{DS}=-15V, I_D=-8A,$ $V_{GS}=-4.5V$	-	35	-	nC
Qgs	Gate-Source Charge		-	5	-	nC
Qgd	Gate-Drain("Miller") Charge		-	10	-	nC
td(on)	Turn-on Delay Time	$V_{DD}=-10V, I_D=-4A,$ $V_{GS}=-4.5V,$ $R_{GEN}=2.5\Omega$	-	11	-	ns
tr	Turn-on Rise Time		-	35	-	ns
td(off)	Turn-off Delay Time		-	30	-	ns
tf	Turn-off Fall Time		-	10	-	ns
IS	Maximum Continuous Drain to Source Diode Forward Current		-	-	-8	A
ISM	Maximum Pulsed Drain to Source Diode Forward Current		-	-	-32	A
VSD	Drain to Source Diode Forward Voltage	$V_{GS}=0V, I_S=-8A$	-	-0.8	-1.2	V

Notes:1. Repetitive Rating: Pulse Width Limited by Maximum Junction Temperature

2. Pulse Test: Pulse Width≤300μs, Duty Cycle≤2%

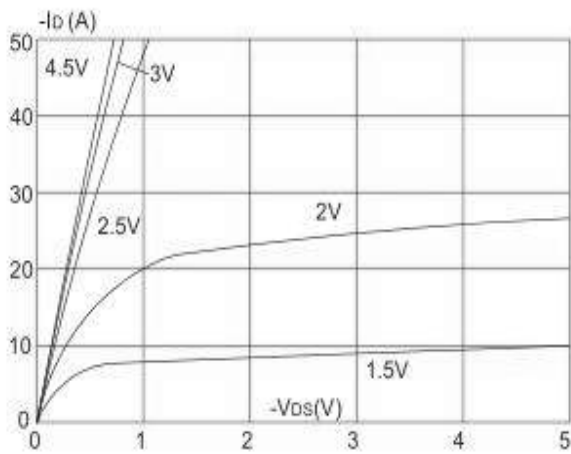
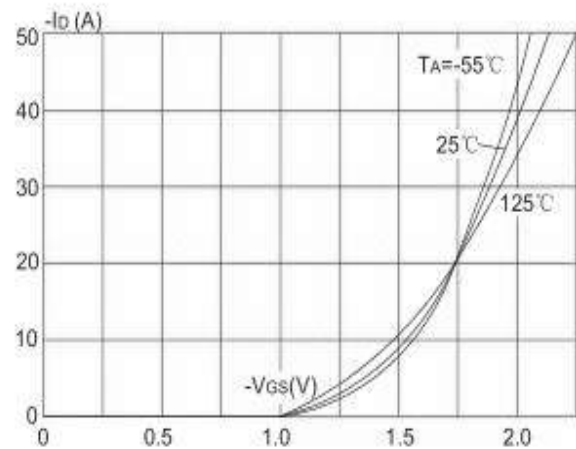
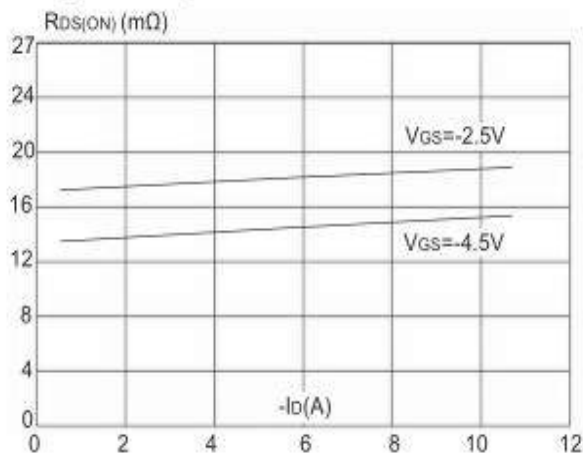
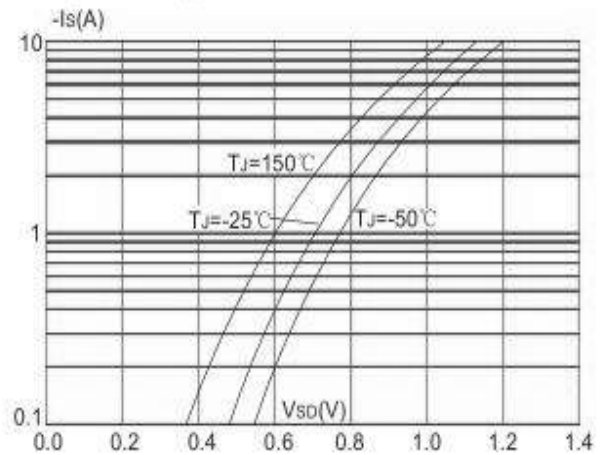
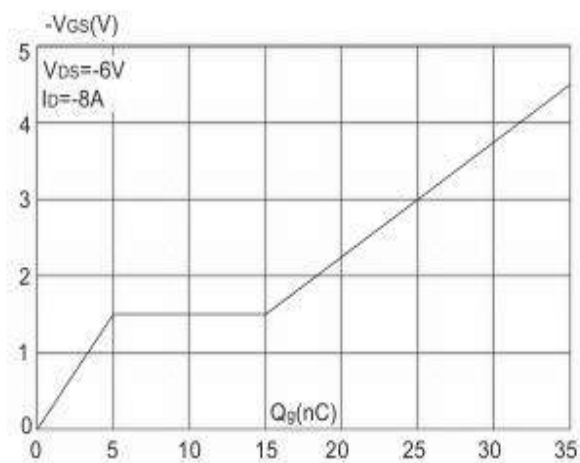
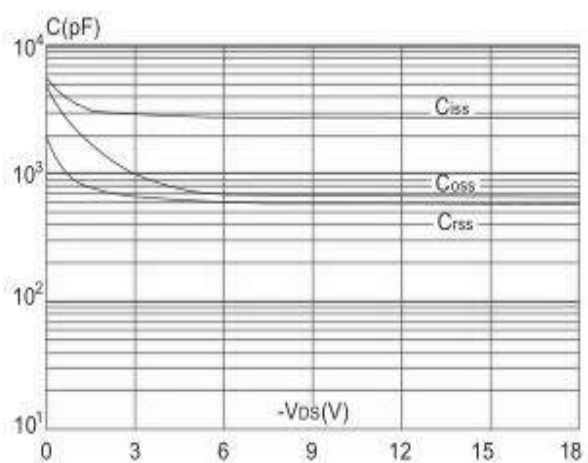
Typical Characteristics

Figure1: Output Characteristics

Figure 2: Typical Transfer Characteristics

Figure 3: On-resistance vs. Drain Current

Figure 4: Body Diode Characteristics

Figure 5: Gate Charge Characteristics

Figure 6: Capacitance Characteristics

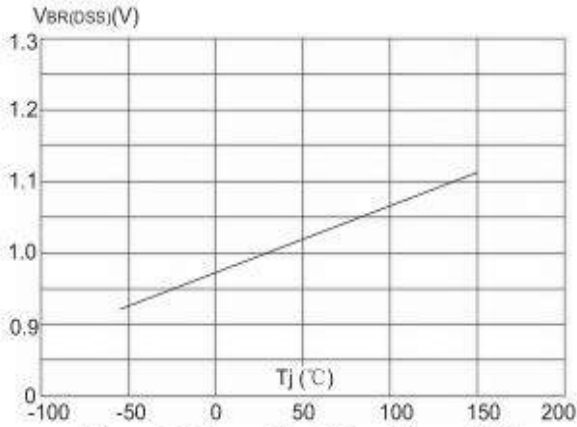

Figure 7: Normalized Breakdown Voltage vs. Junction Temperature

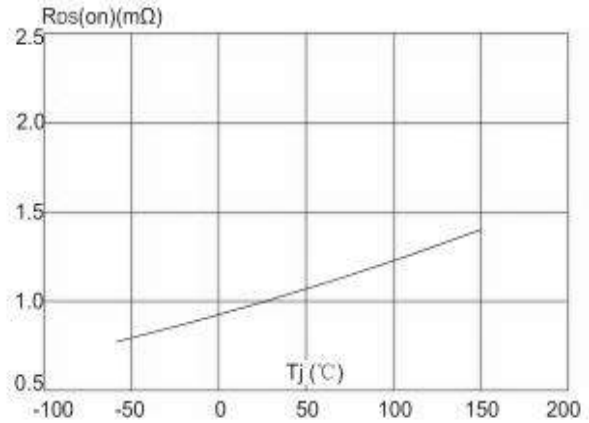

Figure 8: Normalized on Resistance vs. Junction Temperature

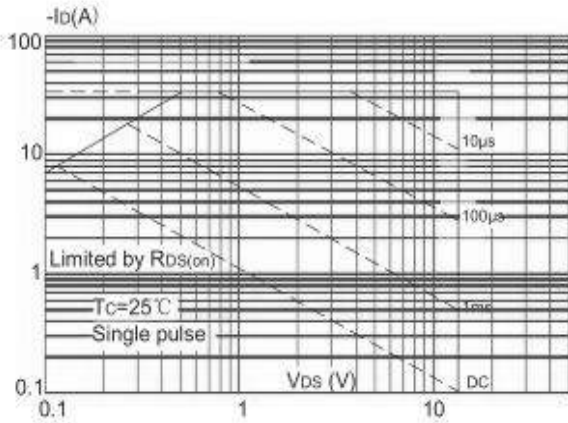

Figure 9: Maximum Safe Operating Area

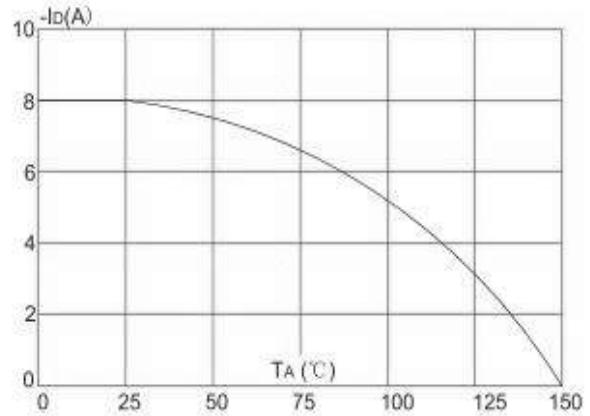

Figure 10: Maximum Continuous Drain Current vs. Case Temperature

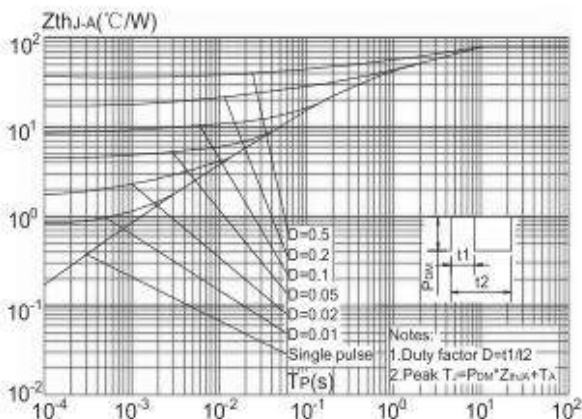
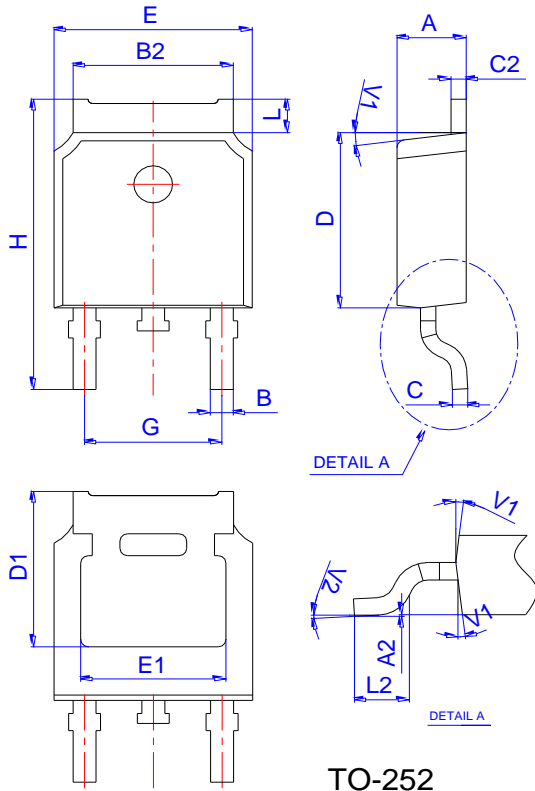
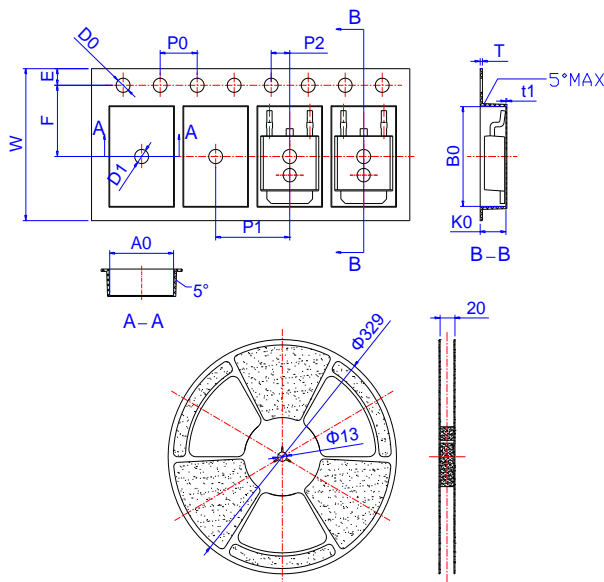

Figure.11: Maximum Effective Transient Thermal Impedance, Junction-to-Ambient

Package Mechanical Data

TO-252

Ref.	Dimensions					
	Millimeters			Inches		
	Min.	Typ.	Max.	Min.	Typ.	Max.
A	2.10		2.50	0.083		0.098
A2	0		0.10	0		0.004
B	0.66		0.86	0.026		0.034
B2	5.18		5.48	0.202		0.216
C	0.40		0.60	0.016		0.024
C2	0.44		0.58	0.017		0.023
D	5.90		6.30	0.232		0.248
D1	5.30REF			0.209REF		
E	6.40		6.80	0.252		0.268
E1	4.63			0.182		
G	4.47		4.67	0.176		0.184
H	9.50		10.70	0.374		0.421
L	1.09		1.21	0.043		0.048
L2	1.35		1.65	0.053		0.065
V1		7°			7°	
V2	0°		6°	0°		6°

Reel Specification-TO-252

Ref.	Dimensions					
	Millimeters			Inches		
	Min.	Typ.	Max.	Min.	Typ.	Max.
W	15.90	16.00	16.10	0.626	0.630	0.634
E	1.65	1.75	1.85	0.065	0.069	0.073
F	7.40	7.50	7.60	0.291	0.295	0.299
D0	1.40	1.50	1.60	0.055	0.059	0.063
D1	1.40	1.50	1.60	0.055	0.059	0.063
P0	3.90	4.00	4.10	0.154	0.157	0.161
P1	7.90	8.00	8.10	0.311	0.315	0.319
P2	1.90	2.00	2.10	0.075	0.079	0.083
A0	6.85	6.90	7.00	0.270	0.271	0.276
B0	10.45	10.50	10.60	0.411	0.413	0.417
K0	2.68	2.78	2.88	0.105	0.109	0.113
T	0.24		0.27	0.009		0.011
t1	0.10			0.004		
10P0	39.80	40.00	40.20	1.567	1.575	1.583